



Digital Radiocommunication Testers CMD 54/57

For production, installation and service of GSM, PCN and PCS base stations

Rohde & Schwarz has an extensive know-how in the field of digital radio measurements. This know-how is fully utilized in the design concept of CMD 54 and CMD 57.

Digital Radiocommunication Testers CMD 54/57 are two advanced top-class instruments for measurements on base stations (BTS) and BTS modules. CMD 54 is designed for measurements in line with:

- GSM
- E-GSM
- UIC – European train radiotelephony

CMD 57 additionally covers the following standards:

- PCN/DCS 1800
- PCS/DCS 1900

The main applications are:

- Module testing in production
- Final testing with A_{bis} control
- Installation with A_{bis} control
- Service with test mobile functionality

CMD is the first compact radiocommunication tester worldwide allowing measurements on transmitters and receivers of base stations without affecting telephone calls in progress.

The solution:

CMD



ROHDE & SCHWARZ

CMD 54/57 – talents for many applications

Introduction

With the two Digital Radiocommunication Testers CMD 54/57 Rohde & Schwarz is setting another milestone in GSM radio measurements. These testers combine compact size with high measurement accuracy and speed. They are suitable both for stationary and mobile use and feature great ease of operation and high reliability.

Operation is extremely easy and requires no detailed GSM knowledge. The high-contrast LCD display with softkeys on both sides allows menu-guided convenient callup of test routines.

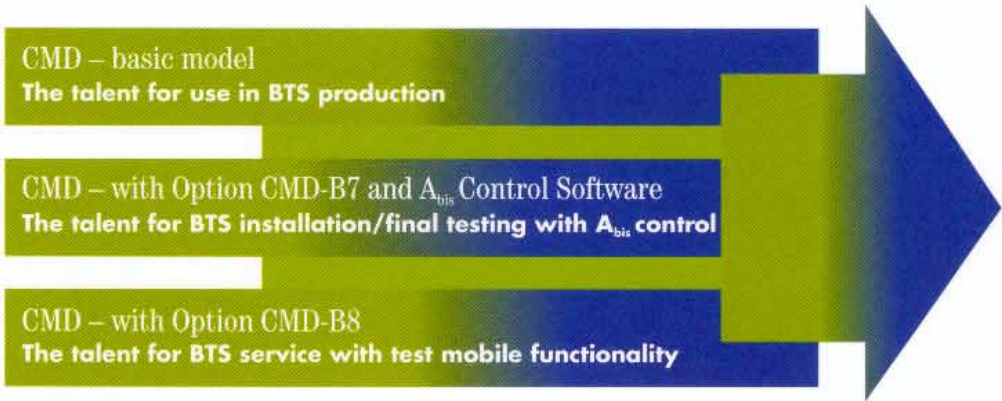

• Wide dynamic range	>72 dB
• High measurement speed	60 s for spectrum due to modulation
• Signalling software	Call setup by means of RF signalling
• A _{bit} card and control software	Control of BTS
• Test mobile functionality	Main functions of a mobile phone
• Speech coder/decoder	Checking the speech quality

The key features at a glance

Characteristic/function	Benefit/application
Transmitter measurements	
Dynamic range >72 dB	Checking the power ramps and output spectrum of the BTS transmitter for compliance with the dynamic range specified by GSM
Measurement of power ramps	Checking the switching characteristics of the BTS transmitter
Phase and frequency error	Testing the modulation characteristics of the BTS transmitter including statistical function
Extremely fast measurement of spectrum due to modulation or switching	Detecting interference to the BTS transmitter at adjacent frequencies, due to modulation or switching
Receiver measurements	
Measurement of bit error rate (BER) via A _{bit} /IEEE bus/RS-232-C interface, BTS loopback or CMD loopback	Testing the BTS receiver characteristics by adaptation to specific implementation in the BTS
Measurement of adjacent timeslot rejection with up to 50 dB higher level	Measuring the automatic gain control (AGC) of the BTS with high level difference between used and adjacent timeslot; simulation of different BTS receive levels
Level error <1 dB at -104 dBm	Reproducible and conclusive measurements even at low output levels especially at the sensitivity limits of the receiver
Other measurements	
Echo test	Subjective test of speech quality with call established
Module test	Complete transmitter measurements even without signalling or time synchronization
Multifunction RF generator	Ideal for alignment of receiver modules
DC current and voltage measurement	Optimized for pulsed signals; replaces external measuring instruments
AF measurement facilities and 60-MHz frequency counter (optional)	Replaces external frequency counter; ideal for measuring reference frequencies
Flexible use	
Various BTS synchronization facilities as to time and frequency	Easy integration of measuring instrument into operational environment and problem-free adaptation to the specific synchronization signals of a BTS
Remote control via RS-232-C and IEC/IEEE bus interface	SCPI-compatible for easy generation of user-specific control programs
Low cost of ownership	
Software update via interface	No need to open the instrument; simple download of the latest software version via the RS-232-C interface
3 years of warranty	The optional warranty of 3 years allows the instruments to be utilized at calculable costs

Main criteria for the decision-maker

The requirements...

The solution:

CMD

...in production

- Easy integration of measurement facilities into production line
- Testing of BTS receiver and transmitter modules without signalling and via different production-specific interfaces
- High speed in particular on the IEC/IEEE bus to achieve high production throughput
- Easy program generation for the IEC/IEEE bus

Details: see page 6

- Numerous synchronization and trigger facilities
- Module test allowing measurements even on non-pulsed signals
- Multifunction RF generator for measurements on receiver modules
- CMD replaces a variety of measuring instruments such as ammeter/voltmeter etc
- Extremely fast IEC/IEEE bus
- SCPI-compatible command set for fast program generation

...in BTS final test/installation

- BTS measurements by means of signalling
- Call setup for signalling test
- Audio check
- Control of complete BTS system via A_{bis} interface
- Automatic test run
- Generation of user-specific A_{bis} control applications
- Simple modification in case of BTS software updates

Details: see

The solution:

CMD

... and in general

- Great measurement accuracy
- High measurement speed
- Ease of operation
- Easy to transport
- Low purchase and maintenance costs

- CMD 54 and CMD 57 are of modular design and thanks to numerous options adaptable to the large variety of base station measurements
- These digital radiocommunication testers feature a logical and straightforward measurement concept from production and installation through to service of base stations

Digital Radiocommunication Tester CMD 57 with options

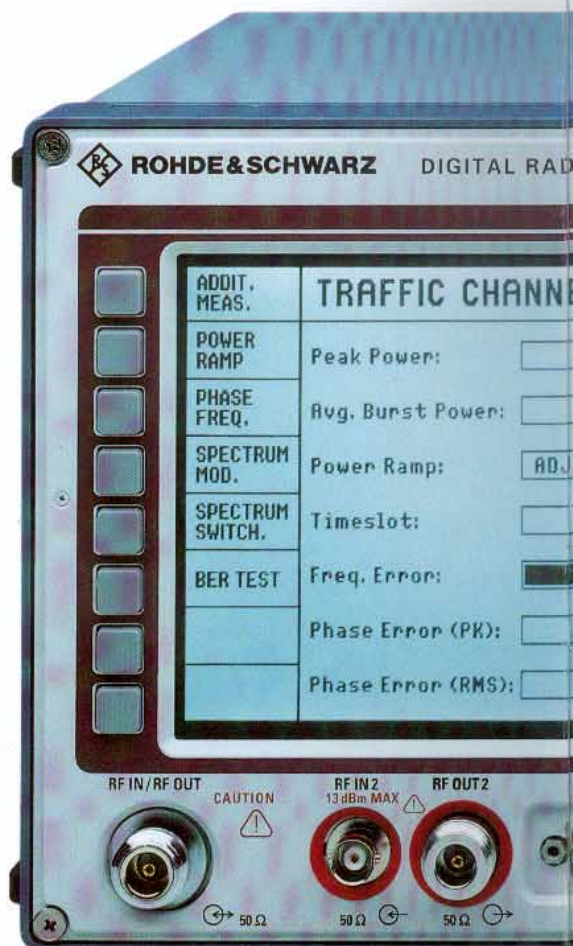

The solution:

CMD

- Synchronization to RF carrier with signalling information
- Call setup using RF signalling software
- Speech coder for audio tests
- Control of BTS of different manufacturers via A_{bis} interface
- A_{bis} control: software in external notebook or resident in CMD
- Automatic test program for complete functional test

page 8

The solution:

CMD

...in BTS service

- Measurements on BTS during ongoing operation
- Transmitter and receiver measurements
- Telephone calls in progress are not affected
- Testing of retrofitted transmitter/receiver modules without interruption of operation

- CMD features the main functions of a test mobile and excellent measurement characteristics
- CMD can be fitted with selective filter, signalling software and SIM card reader
- CMD is able to measure receivers during ongoing operation by monitoring the bits received at the A_{bis} interface

Details: see page 10

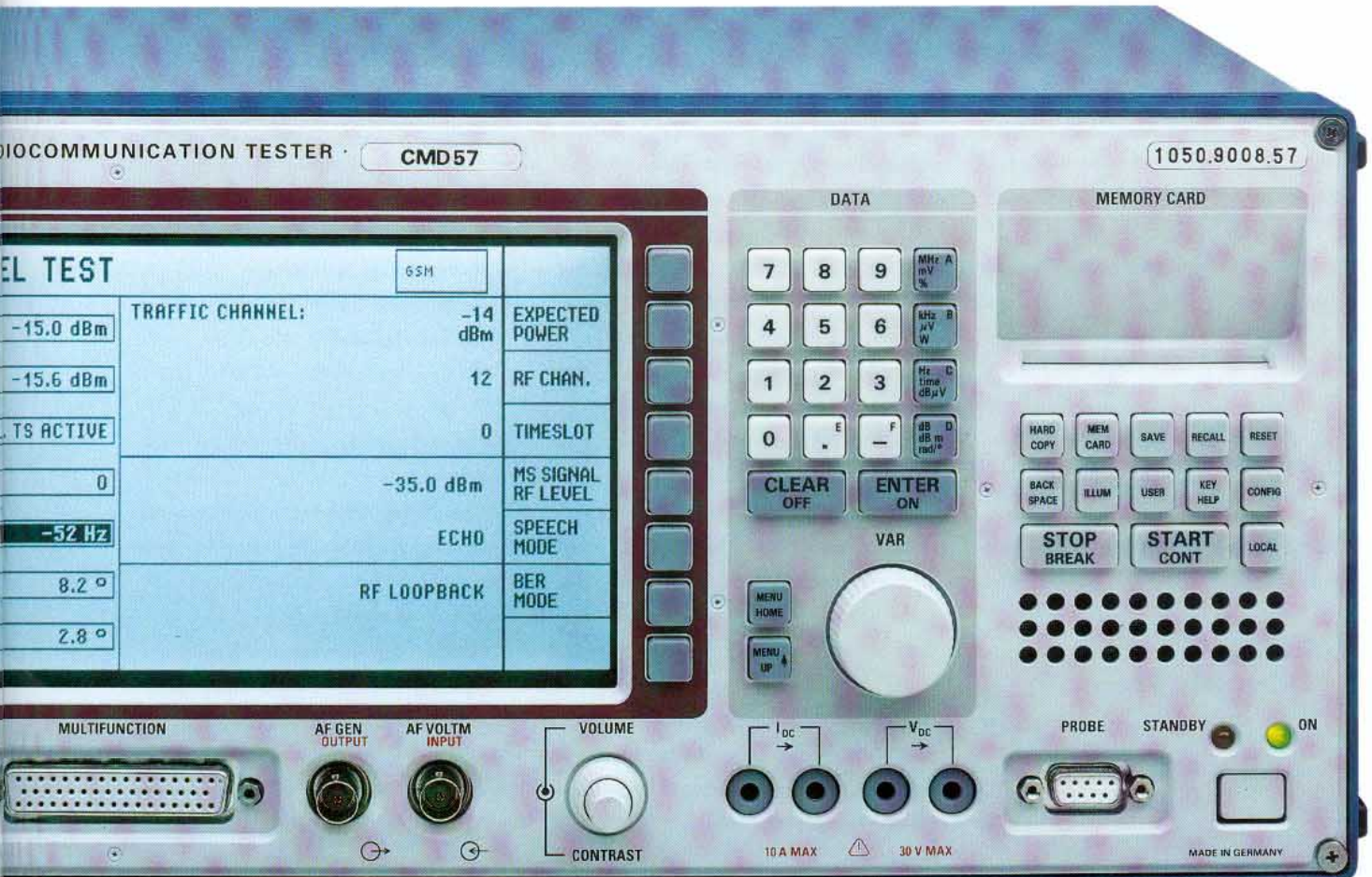

The technical features in detail

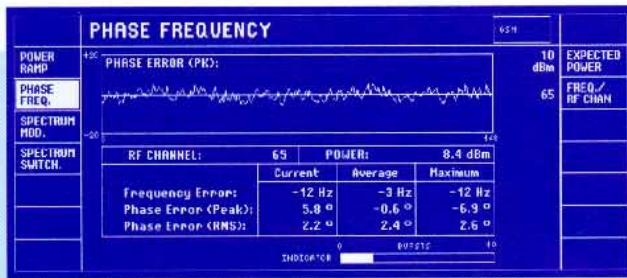

CMD determines phase and frequency errors including maximum and average values

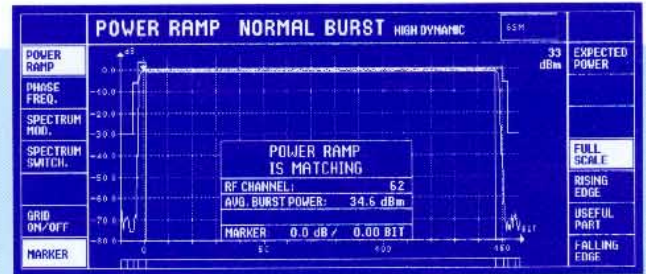

CMD allows the power ramp to be measured with high dynamic range; with graphic display, the zoom function enables application-oriented resolution of parts of the displayed curve

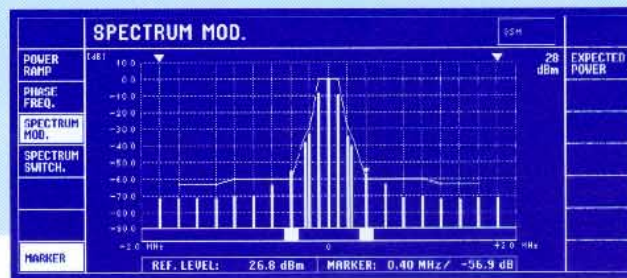

The spectrum due to modulation and switching can be measured in line with GSM specifications within a minimum of time and graphically displayed; the built-in marker function allows the measured value of each individual spectral line to be called up

The instruments

Digital Radiocommunication Testers CMD 54/57 are ideal for measurements on complete base station systems as well as on individual transmitter and receiver modules.

CMD 54 is designed for measurements in the frequency range:

- 800 to 1 000 MHz
- GSM
- E-GSM
- UIC – European train radiotelephony (optional)

CMD 57 covers the following additional frequency range:

- 1.7 to 1.9 GHz
- PCN/DCS 1800
- PCS/DCS 1900 (optional)

The user interface

Operation

The CMD is extremely easy to operate and requires no detailed GSM knowledge. The high-contrast monochrome LCD display with softkeys on both sides allows menu-guided convenient callup of test routines with various preset GSM-specific parameters.

Simple configuration

All parameters can be individually modified in the configuration menus, thus allowing for instance easy adaptation to stringent user-specific tolerances. If parameters have been modified with respect to the GSM specifications, this will immediately be shown on the display.

Additional attenuators, cables and amplifiers are often required for connecting the BTS. These are automatically taken into account by the CMD when calculating the measurement results.

Further advantages

- Protection against incorrect settings
- Extremely easy program generation for computer-controlled operation
- Software update via RS-232-C interface
- Compact size and low weight thanks to LSI technology
- Selftest and automatic alignment for high reliability

Transmitter measurements

The following GSM-specific measurements are available for transmitter testing:

- Power ramping
- Phase/frequency error
- Spectrum due to modulation
- Spectrum due to switching

Measurement results on the traffic channel (TCH) of the transmitter are obtained simply by switching to the corre-

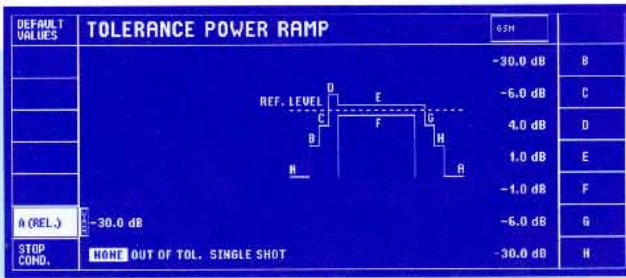

User-defined tolerances, in the example shown for measurement of the power ramp, can easily be entered via configuration menus

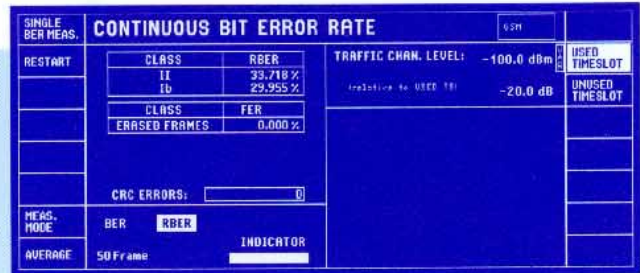

The sensitivity of a transceiver module of the base station is verified by means of a bit error rate (BER) test in the RF loopback mode

Bit error rates are shown separately according to bit classes. The level of unused timeslots may be up to +50 dB above that of the timeslot used



sponding menu: depending on the selected function, the power ramp, phase and frequency error or the spectrum measurement will be graphically displayed. Statistical functions such as maximum, minimum and average values are available for some measurements.

Power ramp

The CMD is able to measure the power ramp with the full dynamic range of >72 dB (phase I) specified by GSM. With graphic display, the zoom function enables application-oriented resolution of parts of the displayed curve.

Phase and frequency error

The CMD performs these measurements upon recognition of the training sequence in line with the GSM specifications and outputs the results in graphical and numerical form. A bargraph is available for alignments.

Spectrum

Thanks to digital signal processing (DSP), the spectrum due to modulation or switching can be measured and displayed by the CMD in line with the GSM specifications within an extremely short time. The marker function allows the measured value of each spectral line to be called up. The CMD evaluates for the modulation spectrum for instance 500 bursts on the selected RF channel and each of its 22 offset frequencies within 60 s.

Receiver measurements

Bit error rate

The BER measurement is an essential criterion for evaluating the receiver characteristics of a complete BTS system or a receiver module. The CMD provides various possibilities of measuring the bit error rate, either by an internal mode or supported by the device under test.

In the RF loopback mode of the BTS or using the optional *A_{bis}* Interface CMD-B7 the bit sequence received by the BTS can be made available to the CMD for calculating the bit error rate. Continuous measurement as well as preselectable single measurements considerably simplify operation for many applications.

Adjacent timeslot rejection

An essential criterion is the response of the receiver to fast level variations at the input. The CMD can raise the level of all unused timeslots to up to 50 dB above the level of the used timeslot, thus heavily burdening the receiver during BER measurement.

Applications in production

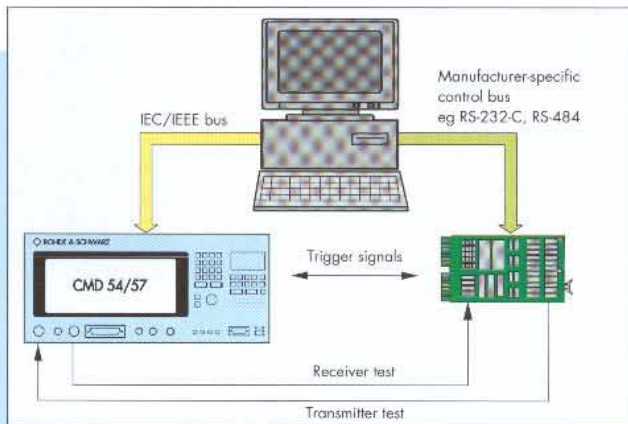

Typical test setup in module production: CMD 54/57 is remote-controlled via the IEC/IEEE bus, while the DUT is controlled via a manufacturer-specific bus

CMD in practical use: testing of transmitter and receiver modules



The requirements in production

- Easy integration of measurement facilities into production line
- Testing of BTS receiver and transmitter modules without signalling and via different production-specific interfaces
- High speed in particular on the IEC/IEEE bus to achieve high production throughput
- Easy program generation for the IEC/IEEE bus

The solution:

CMD

Easy to integrate and versatile

The many synchronization and trigger facilities (different bit and frame clocks, CO carrier and other reference frequencies, reference frequency of A_{bis}) as well as additionally built-in analog measurement facilities allow the CMD to be optimally matched to the device under test and to the test environment.

Transmitter/receiver measurements

The module test allows all essential transmitter measurements to be carried out without signalling. Measurements are possible on pulsed and non-pulsed signals. Modulated or unmodulated RF

carriers (with or without power ramping and with or without frequency offset) ensure reliable testing of receiver modules.

CMD replaces expensive additional instruments

Additional instruments are not required when using the CMD, since they are already or can be integrated:

- ammeter/voltmeter
- RF and AF signal generators
- frequency counter
- power meter

The CMD voltmeter/ammeter is designed for pulsed signals with GSM-specific time constant; AF voltmeter, AF generator and frequency counter enable measurements to be performed on the audio interface as well as measurement of reference frequencies.

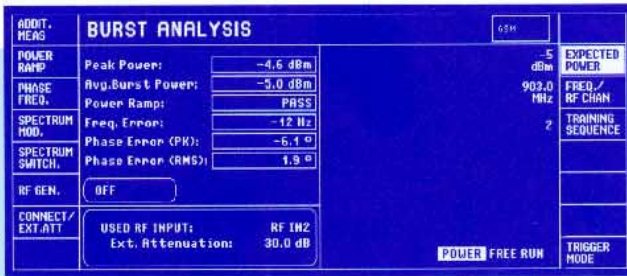

The module test allows measurements on pulsed and non-pulsed signals at discrete frequencies

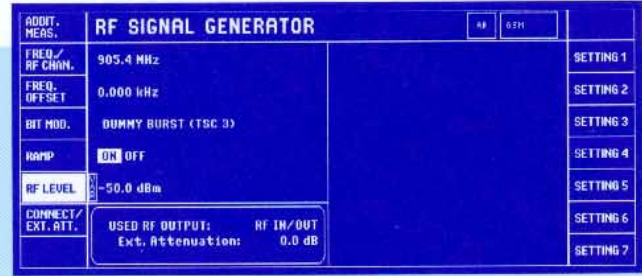

A versatile RF generator is available for alignments. Sofkeys can be allocated to frequently used settings

The CMD voltmeter/ammeter is designed for pulsed signals with GSM-specific time constant; AF voltmeter, AF generator and frequency counter enable measurements to be performed on the audio interface

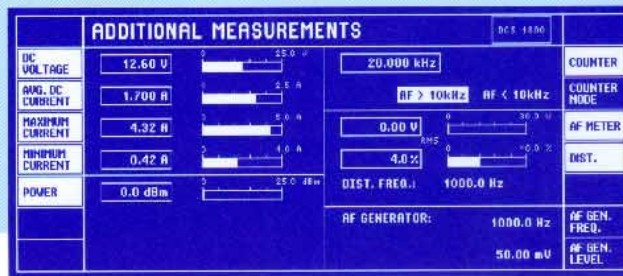

High speed

High measurement speed is no problem with remote control via the SCPI-compatible IEC/IEEE bus. Remote control is alternatively possible via the RS-232-C interface using the same command set (use of notebook).

Ease of programming

The SCPI-compatible command set allows convenient programming of the IEC/IEEE bus. During program generation all commands for troubleshooting can be shown on the CMD display. To enhance speed, they can be blanked after successful testing.

Recommended system configuration

The basic configuration in conjunction with Option CMD-B3 is sufficient for many applications.

Where the frequency range for PCS 1900 is to be covered too, Option CMD-B19 is required.

Options CMD-B6 and -B61 are required for remote control via the IEC/IEEE bus.

The optional AF Measurement Unit with Frequency Counter CMD-B41 is recommended for further analog measurements.

Applications in BTS final testing/installation

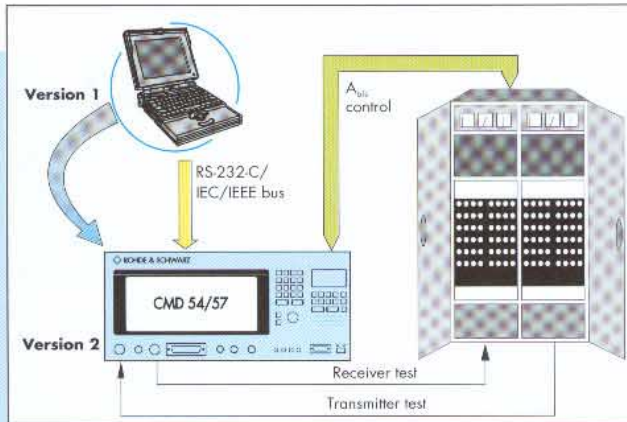

Typical test setup for BTS final testing or installation. The CMD controls the base station via the A_{bis} interface. The control software is either run on an external notebook (version 1) or directly in the CMD (version 2)

CMD in practical use: a base station is controlled via the A_{bis} interface

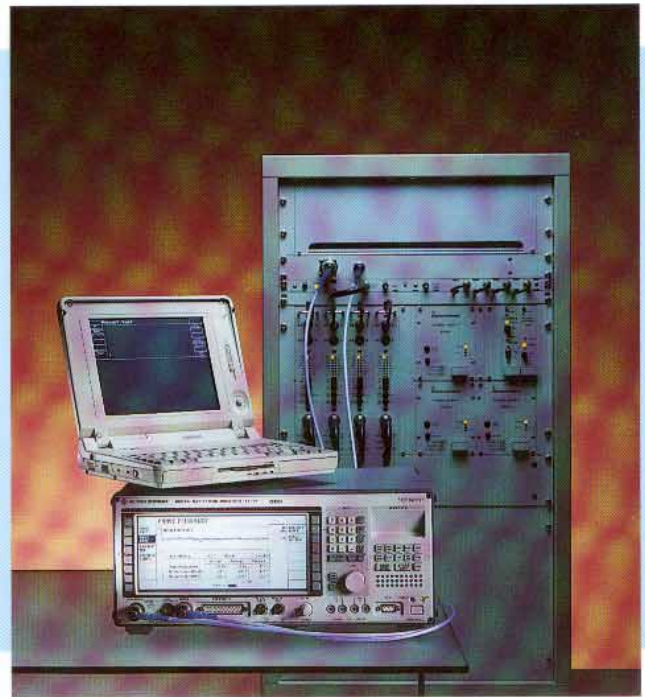

The requirements in BTS final testing/installation

- Measurements on BTS by means of signalling
- Call setup for signalling test
- Audio check
- Control of complete BTS system via A_{bis} interface
- Automatic test run

The solution:

CMD

Measurements on active base stations

For BTS final testing, measurements have to be performed on active base stations which, controlled by external devices, send RF carriers with signalling information (eg C0 carrier and TCH). The basic CMD model is an efficient tool for both transmitter and receiver measurements.

With synchronization to the C0 carrier, the transmitted power as well as the phase and frequency error are shown on the LCD. This allows a rapid conclusion to be made on the functioning of the BTS.

Call setup/signalling

The CMD is provided with signalling characteristics when using the optional *Signalling Software* CMD-K30. After synchronization to the base station, a complete call can be set up by means of signalling at the RF interface. Immediately after setting up a traffic channel, all relevant RF data are measured and displayed.

The following functions are supported:

- mobile originated calls
- base station originated calls
- location update
- call release

Since the signalling information sent by the BTS is evaluated by the CMD in realtime, the following functions are also supported:

- frequency hopping
- channel change
- change of timeslot

Recommended system configuration

For signalling tests it is recommended to use the optional *Signalling Software* CMD-K30 with the basic model fitted with Option CMD-B3.

For the control of a base station the A_{bis} Interface CMD-B7 plus the appropriate control software are required. The latter is offered in manufacturer-specific software packages.

Option CMD-B19 is required for PCS1900. Options CMD-B6 and

-B61 are required for remote control via IEC/IEEE bus.

Since an appropriate reference frequency is usually not available for field installation, it is recommended to use Option CMD-B2.

Menu example of the application software for A_{bis} control on an external PC

Config Test			
		Measurements selected:	3 (dec)
		Average Power: 5 bursts	
Sel. TRX		Frequency Error (max): bursts	
0...7		Phase Error RMS (max): bursts	1 (dec)
		Phase Error Peak (max): bursts	
Sel. TRX		Frequency Error (avg): bursts	
8...15		Phase Error RMS (avg): bursts	63 (dec)
		Phase Error Peak (avg): bursts	
		IQ BB Measurement: 20 frames	
		BTS Measurement Result: 1 (on)	124 (dec)
		TS selected: 0 1 2 3 4 5 6 7	
		ARFCNs selected: 1 63 124	
Sel. TS		TRXs selected: 1 2 3 4 5 6	
0...7			
Select menu:			Exit Menu

Speech coder for audio tests

If the optional software *Realtime Speech Coder/Decoder* CMD-B5 is additionally installed, the audio quality can also be checked and the BTS tested under realistic conditions.

A_{bis} control

Both for final testing in production and for the installation the network configuration has to be simulated in the measuring instrument and tailored to the specific needs of the individual BTS type.

The CMD features an interesting concept for testing base stations. Via the A_{bis} Interface CMD-B7 and the appropriate BTS-specific CMD software the base station can be controlled and measurements carried out at the RF interface.

Version 1:

Control by external PC

Being remote-controlled via an external notebook, the CMD can execute BTS-specific A_{bis} control programs. These application programs are used for manual control of the BTS. The notebook sends O&M messages via the CMD to the BTS. The following functions are supported:

- BTS reset
- BTS configuration
- software download
- BTS reconfiguration
- TRX activation (TCH, BCCH)
- TRX deactivation

As soon as the BTS has reached the desired status to be tested (eg carrier with maximum power on channel x activated), the typical RF characteristics of transmitter and receiver can be measured. One of the outstanding features of this concept is that the application program can be tailored to the user-specific needs.

Version 2:

Direct control by CMD

As soon as the application program run on the external PC satisfies the requirements of the user, it can be downloaded into the CMD so that for performing the measurements only the CMD is required. The menus of the application program are now displayed on the CMD. Softkeys are provided for selecting A_{bis} control mode or RF measurement.

Automatic testing

The software comes with an application program for each of the two versions allowing fully automatic testing of the BTS.

Applications in BTS service

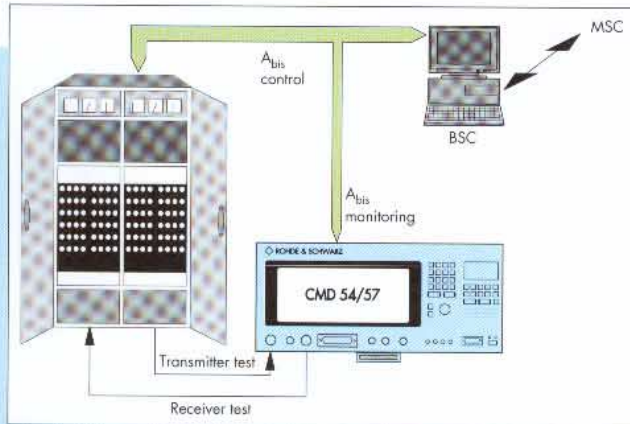

Typical setup for in-service testing. The CMD establishes a call and monitors the bits received at the A_{bis} interface for receiver measurements.

The BTS remains in operation while the CMD performs measurements



The requirements in BTS service

- Measurements on BTS without interruption of operation
- Transmitter and receiver measurements
- Telephone calls in progress are not affected
- Testing of retrofitted transmitter/receiver modules without interruption of operation

The solution:

CMD

Test mobile functionality

The optional *Test Mobile Functionality* CMD-B8 adds an essential feature to the CMD: it operates like a mobile phone and features excellent measurement capabilities. In conjunction with the monitoring function of the optional *A_{bis} Interface* CMD-B7 timeslot-accurate and channel-selective RF measurements can be performed on receivers and transmitters.

Thanks to this concept, CMD is the first compact radiocommunication tester worldwide allowing measurements on transmitters **and** receivers of base stations during ongoing operation. A very important factor is that transmitter and receiver modules can be retrofitted

without interruption of operation. Telephone calls in progress are not affected either.

The optional *Test Mobile Functionality* CMD-B8 comprises the following modules:

- Signalling software for call setup, call holding and call clearing
- SIM card reader for successful identification
- A_{bis} monitoring for BER measurements to test receiver sensitivity (CMD-B7 required)
- Selective filter for adjacent-channel suppression

Recommended system configuration

Options CMD-B8 and CMD-B6 providing all the necessary extensions for a call setup in the network plus a selective filter are required in addition to the basic model fitted with Option CMD-B3. Option CMD-B7 is required for receiver measurements

with the aid of A_{bis} monitoring. Option CMD-B19 is required for PCS 1900.

Remote control is possible via the RS-232-C interface fitted as standard. Since an appropriate reference frequency is usually not available for field installation, it is recommended to use Option CMD-B2.

The optional *Realtime Speech Coder/Decoder* CMD-B5 is available for audio tests.

Where both A_{bis} control and test mobile functionality with A_{bis} monitoring are required, the following configuration is recommended:

Basic model with CMD-B3 + CMD-B6 + CMD-B7 + CMD-K1x + CMD-B8

Typical signalling in progress (layer 3) during call setup

SIGNALLING IN PROGRESS		005 1800
Mobile Originated Call Establishment		
MM: RR-EST-CNF		
MM: L3 message received: Authentication Request		
MM: L3 message sent: Authentication Response		
MM: L3 message received: Identity Request		
MM: L3 message sent: Identity Response		

Signalling software

The signalling protocols in line with the OSI layer model are implemented in the CMD – to the extent required for the measurements. The CMD behaves like a mobile phone in the network. The following functions are supported:

- mobile originated calls
- base station originated call
- location update
- authentication
- call release

Immediately after setting up a traffic channel, all relevant RF data are measured and displayed. Since the signalling information sent by the BTS is evaluated by the CMD in realtime, the following functions are also supported:

- frequency hopping
- change of timeslot
- channel change

SIM card reader

Like a GSM mobile phone the CMD also requires a SIM card reader for proper call setups, since only registered SIM cards provide access to the network. The card reader included in the optional *Test Mobile Functionality* CMD-B8 accepts SIM cards of credit card size and is fitted to the bottom of the instrument so that the size of the instrument is not affected.

A_{bis} monitoring

After a call setup the CMD applies RF signals modulated with CCITT bit pattern to the BTS receiver. Typical levels are in the range <-100 dBm. The level error of the CMD is <1 dB at -104 dBm.

The optional A_{bis} Interface is connected to the BTS – BSC link with high impedance and samples the bits received by the BTS (260-bit speech frames) in the

relevant timeslot. The detected bit errors are displayed in the BER measurement menu.

Selective filter

The contradictory requirements for broadband measurement and high selectivity are satisfied with the aid of a special filter which provides reliable suppression of interfering carriers close to the channel selected (typ. $\geq \pm 3$ channels). The measurement accuracy is not significantly affected. The filter features a typical attenuation of 30 dB at 600 kHz from the carrier frequency.

The options in detail

Option		Characteristics	Uses/ recommendation
OCXO Reference Oscillator	CMD-B1	Ensures high absolute accuracy, minimum temperature-dependent drift and especially high long-term stability	For measurements with exacting requirements on frequency stability
OCXO Reference Oscillator	CMD-B2	Oven crystal with highest long-term stability. Ensures compliance with tolerances specified by GSM	For highly demanding requirements on frequency stability to GSM 11.20
Multi-Reference Frequency Inputs/Outputs	CMD-B3	For synchronizing DUT and measuring instrument with internal or external frequencies	For all applications
AF Measurement Unit with Frequency Counter	CMD-B41	This option comprises an AF generator, an AF voltmeter, a distortion meter and a frequency counter for measurements on the audio interface or on modules. CMD-B41 allows measurements up to 60 MHz	For all applications to replace external devices
Realtime Speech Coder/Decoder	CMD-B5	This option converts digital speech signals into analog signals (and vice versa)	In conjunction with CMD-K1x, CMD-K30 or CMD-B8
Adapter for CMD-B6x Options	CMD-B6	CMD-B6 is required for the use of Options CMD-B61 and -B62	
IEC/IEEE Bus Interface	CMD-B61	Remote control alternative to the RS-232-C interface fitted as standard	For fast remote control of the CMD
Memory Card Interface	CMD-B62	Memory cards are a versatile medium for storing instrument settings	For users needing identical equipment configurations and for A _{bis} control
A _{bis} Interface	CMD-B7	A _{bis} card for BER measurements at this interface	For sensitivity measurements; required for A _{bis} control
Test Mobile Functionality	CMD-B8	Adds signalling software, SIM card reader and selective filter to the basic model (CMD-B6 required)	
DCS1900 Base Station Test	CMD-B19	Allows tests on DCS1900 base stations	
A _{bis} Control Software	CMD-K10, -K11 and others	Comprises the A _{bis} control software for a certain base station including application program for manual and automatic testing (CMD-B7 required)	Available on request
Signalling Software	CMD-K30	Adds call setup functionality to the basic model (this functionality is also contained in CMD-B8)	For signalling purposes eg in test network or in production
Modification Kit High-Level 2nd RF Output (13 dBm)	CMD-U2	The standard output level range of the second output is approx. -33 to -120 dBm; the level range +13 to -60 dBm is offered alternatively	For CMD 54 only
Modification Kit High-Level 2nd RF Output (11 dBm)	CMD-U3	The standard output level range of the second output is approx. -35 to -120 dBm; the level range +11 to -60 dBm is offered alternatively	For CMD 57 only
Trigger Inputs/Outputs	CMD-U5	The time synchronization signals can additionally be applied to BNC connectors on the rear panel. For monitoring purposes the demodulated I/Q signals are brought out at BNC sockets (rear panel)	
Memory Card	CMD-Z1	Formatted PCMCIA-compatible memory card for storing instrument settings	CMD-B62 required
Carrying Bag	CMD-Z40	Multifunction carrying bag for the instrument, suitable to be carried in hand, over the shoulder or on the back	See photo on foldout page at the back
UIC European Train Radio	CMD-K80	Allows measurements in the UIC frequency range – European train radiotelephony based on GSM-identical signalling	

Specifications

Common data of CMD 54/57

Timebase TCXO	standard
Nominal frequency	10 MHz
Frequency drift in temperature range 0 to 35°C	$\leq 1.5 \times 10^{-6}$
Aging	$\leq 0.5 \times 10^{-6}$ /year (at 35°C)
Timebase OCXO	Option CMD-B1
Nominal frequency	10 MHz
Frequency drift in temperature range 0 to 50°C	$\leq 1 \times 10^{-7}$
Aging	$\leq 2 \times 10^{-7}$ /year $\leq 5 \times 10^{-9}$ /day after 30 days of operation
Warmup time (at 25°C)	approx. 5 min
Timebase OCXO	Option CMD-B2
Nominal frequency	10 MHz
Frequency drift in temperature range 0 to 50°C (referred to 25°C)	$\leq 5 \times 10^{-9}$
with instrument turned by 90° (at 25°C)	$\leq 1 \times 10^{-8}$
after 2 h warmup time (at 25°C, after 24 h out of operation)	$\leq 5 \times 10^{-9}$
Aging after 30 days of operation and under constant operat. conditions	$\leq 3.5 \times 10^{-8}$ /year $\leq 5 \times 10^{-10}$ /day
Warmup time (at 25°C)	approx. 10 min
DC voltmeter	
Measurement range	0 to ± 30 V
Resolution	10 mV
Error	$\leq 2\%$ + resolution
DC ammeter	
Operating modes	current averaging with GSM-adapted time constant, current peak measurement (maximum and minimum)
Measurement range	0 to ± 10 A
Common-mode rejection	± 30 V
Resistance	50 m Ω
Resolution for current averaging	1 mA/10 mA
Resolution for peak measurement	10 mA
Residual indication (no current at input)	≤ 10 mA (at room temperature)
Error	$\leq 2\%$ + residual indication + resolution
AF Measurement Unit	Option CMD-B41
AF generator	
Frequency range	50 Hz to 10 kHz
Frequency resolution	0.1 Hz
Frequency error	same as timebase + half resolution
Level range	10 μ V to 5 V
Level resolution	10 μ V at a voltage < 1 mV $\leq 1\%$ at a voltage ≥ 1 mV $\leq 5\%$ at a voltage ≥ 1 mV
Level error	$\leq 0.5\%$
Distortion	$\leq 0.5\%$
Max. output current	20 mA
Output impedance	< 5 Ω
AF voltmeter	
Frequency range	50 Hz to 10 kHz
Measurement range	0.1 mV to 30 V
Resolution	100 μ V at a voltage < 10 mV 1% at a voltage ≥ 10 mV
Error	$\leq 5\%$ + resolution
Input impedance	1 M Ω
Distortion meter	
Frequency range	300 Hz to 3 kHz
Input level range	100 mV to 30 V
Resolution	0.1% of THD
Inherent distortion	$\leq 0.5\%$
Error	$\leq 5\%$ + inherent distortion
Measurement bandwidth	10 kHz

AF counter	
Frequency range	20 Hz to 10 kHz
Input level range	10 mV to 30 V
Resolution	≤ 1 Hz
Error	same as reference + resolution
Input impedance	1 M Ω

IF counter	
Frequency range	10 kHz to 60 MHz
Input level range	100 mV _{rms} to TTL
Resolution	1 Hz
Error	same as reference + resolution
Input impedance	approx. 1 M Ω 100 pF

GSM-specific measurement of spectrum

Spectrum due to modulation	
Test method	relative measurement, averaging
Resolution filter bandwidth	30 kHz
Measurement at an offset of	100/200/250/400/600/800/1000/1200/1400/1600 and 1800 kHz
Dynamic range for offset > 400 kHz	better than specified by GSM max. 80 dB
Error	$\leq \pm 1.5$ dB
Spectrum due to switching	
Test method	relative measurement, Max Hold over several measurements
Resolution filter bandwidth	30 kHz
Measurement at an offset of	400/600/1200 and 1800 kHz
Dynamic range for offset > 400 kHz	better than specified by GSM max. 80 dB, with SW correction max. 76 dB, without SW correction
Error	≤ 1.5 dB (dynamic range < 50 dBc) ≤ 2.5 dB (dynamic range 50 to 80 dBc)

Multi-Reference Frequency Inputs/Outputs Option CMD-B3

Synchronization input:	
Frequency (selectable)	GSM bit clock (270.8 kHz), 2/4/16 times GSM bit clock, 1 to 13 MHz in 1-MHz steps, 2.048/16.384/26/39/52 MHz approx. 100 Ω
Impedance Level	0 dBm to TTL
Synchronization output 1:	
Frequency	10 MHz with internal reference or frequency at synchronization input with external reference TTL, R _{out} = 50 Ω
Level	
Synchronization output 2:	
Frequency (selectable)	GSM bit clock, 2/4/16 times GSM bit clock, 1/2/4 or 13 MHz TTL, R _{out} = 50 Ω
Level	
A_{bis} Interface	Option CMD-B7
Receive channel (traffic/speech)	75 Ω /high-impedance, unbalanced; 120 Ω /high-impedance, balanced; 16 kbit/s, timeslot selectable

Interfaces	RS-232-C (9-pin), Centronics (25-pin)
-------------------	---------------------------------------

General data

Rated temperature range	0 to +45°C to DIN IEC 68-2-1/2
Storage temperature range	-40 to +60°C
Electromagnetic compatibility	complies with requirements of Europe: an EMC directive (89/336/EEC)
Mechanical resistance	
Sine vibration	to DIN IEC 68-2-6, 5 to 55 Hz, 0.15 mm amplitude, 2 cycles
Random vibration	to DIN 40046 part 24, 10 to 300 Hz, 10 m/s ² rms, 5 min/axis
Shock	to MIL-STD-810D, 400 m/s ² , shock spectrum in 6 main axes
Power supply	100 to 120 V AC $\pm 10\%$ 200 to 240 V AC $\pm 10\%$ 50 to 400 Hz $\pm 5\%$
Power consumption (without options)	approx. 85 W
Electrical safety	VDE 0411, class I
Dimensions (W x H x D)	435 mm x 192 mm x 363 mm
Weight (without options)	approx. 14 kg

Specific data of CMD 54 (GSM)

RF generator

Frequency range	GSM: 890.2 to 914.8 MHz E-GSM: 880.2 to 890.0 MHz
Frequency accuracy	same as timebase
Resolution	GSM channel spacing 200 kHz
Settling time	<3 ms for phase error <2°
Output level (RF IN/OUT)/ (OUTPUT 2)	-33 to -120 dBm
Resolution	0.1 dB
Level error (RF IN/OUT)/ (OUTPUT 2), burst with max. level	≤1.5 dB (≤1 dB at -104 dBm)
Harmonics (RF IN/OUT)	<-30 dBc
Modulation	GMSK, B x T = 0.3
Phase error	≤4° rms, ≤10° peak

Peak power meter (RF IN/OUT)

Frequency range	800 to 1000 MHz
Measurement range	10 to 47 dBm
Resolution	0.1 dB
Error in GSM band 935.2 to 959.8 MHz	≤0.5 dB + resolution (P > 13 dBm)
VSWR	≤1.3

Phase and frequency error measurement

Frequency range	GSM: 935.2 to 959.8 MHz E-GSM: 925.2 to 935.0 MHz
Level range	
RF IN/OUT	10 to 47 dBm
RF IN 2	-60 to 0 dBm
Inherent phase error	<1.5° rms, <5° peak
Frequency measurement error	<5 Hz + timebase

Burst power measurement

Frequency range	GSM: 935.2 to 959.8 MHz E-GSM: 925.2 to 935.0 MHz
Reference level for full dynamic range	
RF IN/OUT	10 to 47 dBm
RF IN 2	-37 to 0 dBm
Absolute measurement error of peak power	
RF IN/OUT, unsynchronized	same as peak power meter
RF IN/OUT, synchronized to CO carrier	≤1 dB
RF IN 2	≤1 dB
Resolution in active part of timeslot	≤0.1 dB

High-dynamic burst analysis

Relative error of individual test samples	≤1.5 dB to 72 dB below peak power
Dynamic range	>72 dB
Measurement limit RF IN/OUT	<-36 dBm
Measurement limit RF IN 2	<-83 dBm

Specific data of CMD 57 (GSM + DCS)

RF generator

Frequency range	GSM: 890.2 to 914.8 MHz E-GSM: 880.2 to 890.0 MHz DCS 1800: 1710.2 to 1784.8 MHz DCS 1900 ¹⁾ : 1850.2 to 1909.8 MHz
Frequency accuracy	same as timebase
Resolution	GSM channel spacing 200 kHz
Settling time	<3 ms for phase error <2°
Output level (RF IN/OUT)/ (OUTPUT 2)	-35[-37 ¹⁾] to -120 dBm
Resolution	0.1 dB
Level error (RF IN/OUT)/ (OUTPUT 2)	≤1.5 dB (≤1 dB at -104 dBm)
Harmonics (RF IN/OUT)	<-30 dBc
Modulation	GMSK, B x T = 0.3
Phase error	<4° rms, <10° peak

Peak power meter (RF IN/OUT)

Frequency range	800 to 1000/1700 to 1900 MHz
Measurement range	0 to 47 dBm
Maximum RF power	47 dBm pulsed 45 dBm CW 47 dBm CW at room temperature
Resolution	0.1 dB
Error in GSM band 935.2 to 959.8 MHz	≤0.5 dB + resolution (P > 10 dBm)
Error in DCS 1800/1900 band 1805.2 to 1879.8 MHz and 1930.2 to 1989.8 MHz ¹⁾	≤0.8 dB + resolution (P > 4 dBm)
VSWR	≤1.3

Phase and frequency error measurement

Frequency range	GSM: 935.2 to 959.8 MHz E-GSM: 925.2 to 935.0 MHz DCS 1800: 1805.2 to 1879.8 MHz DCS 1900 ¹⁾ : 1930.2 to 1989.8 MHz
Level range	
RF IN/OUT	0 to 47 dBm
RF IN 2	-57[-51 ¹⁾] to 0 dBm
Inherent phase error	≤1.5° rms, ≤5° peak
Frequency measurement error	≤5 Hz + timebase

Burst power measurement

Frequency range	GSM: 935.2 to 959.8 MHz E-GSM: 925.2 to 935.0 MHz DCS 1800: 1805.2 to 1879.8 MHz DCS 1900 ¹⁾ : 1930.2 to 1989.8 MHz
Reference level for full dynamic range	
RF IN/OUT	GSM: 10 to 47 dBm DCS 1800/1900: 0 to 47 dBm -37[-31 ¹⁾] to 0 dBm
RF IN 2	
Absolute measurement error of peak power	
RF IN/OUT, unsynchronized	same as peak power meter
RF IN/OUT, synchronized to CO carrier	GSM: ≤1.3 dB DCS 1800/1900: ≤1.5 dB
RF IN 2	GSM: ≤1.3 dB DCS 1800/1900: ≤1.5 dB
Resolution in active part of timeslot	≤0.1 dB

High-dynamic burst analysis

Relative error of individual test samples	≤1.5 dB to 72 dB below peak power
Dynamic range	>72 dB
Measurement limit RF IN/OUT	GSM: <-36 dBm DCS 1800: <-48 dBm DCS 1900: <-42 dBm
Measurement limit RF IN 2	GSM: <-83 dBm DCS 1800: <-85 dBm DCS 1900: <-79 dBm

1) In DCS1900 mode with Option CMD-B19 fitted.

CMD 54/57 in multicarrier mode (Option CMD-B8)

The specifications apply to all cases, in which interfering carriers (up to 30 dB above useful level) are more than 30 GSM channels away. If there are interfering signals close to the useful carrier, an additional IF filter is switched in (multicarrier mode).

Typical filter characteristics in multicarrier mode

Offset from useful channel (kHz)	Filter suppression (dB)
0	0 (reference)
200	<3
400	>20
600	>33
800	>41
1000	>48

This filter increases the measurement error for phase and power measurements.

Phase and frequency error measurement

Inherent phase error $\leq 2^\circ$ (rms), $\leq 7.5^\circ$ (peak)

Measurement of peak power/burst power

Level error ≤ 1.5 dB

GSM-specific spectrum measurements

The dynamic range specified for the basic model refers to the sum of all input voltage components. The additional GSM carriers appear as strong spurious emissions in the spectrum measurement and have to be taken into account accordingly when evaluating the tolerances.

Typical effects of an interferer on power and modulation measurement results (see diagrams on the right). The characteristics of an interferer close to the carrier have the following effect on the measurement error:

- Power: the lower the power of the interferer, the smaller the measurement error.
- Frequency offset: the larger the frequency offset of the interferer, the smaller the measurement error. In the diagrams on the right an interferer with an offset of $m=3$ or $m=6$ GSM channels has been assumed.
- Spectral purity: the narrower the modulation spectrum of the interferer, the smaller the measurement error. In the diagrams on the right the modulation spectrum to GSM 05.05 with linear interpolation (in the dB/Hz coordinates) has been used (worst case spectrum).
- Number of carriers: the fewer the carriers, the smaller the measurement error. In the example, 1 interferer has been assumed.

The curves shown in the diagrams have been **calculated** assuming the worst case spectrum as interferer, the guaranteed CMD-B8 specifications for phase and power measurement and a typical IF filter characteristic.

The **measured values** are based on a real GSM spectrum, typical CMD-B8 specifications and typical filter characteristic.

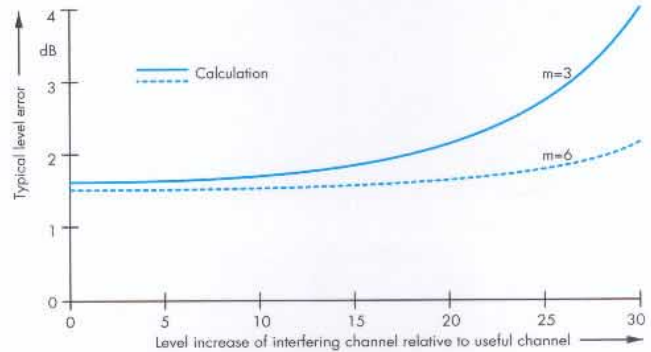
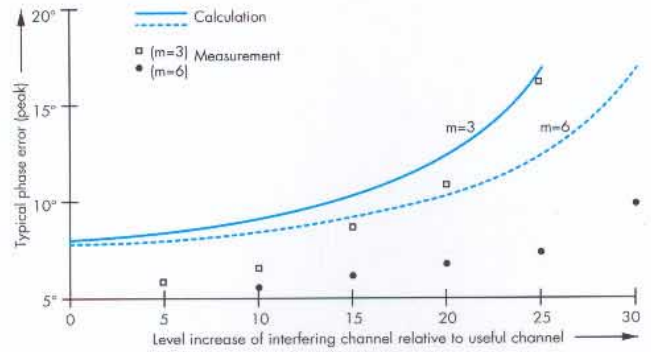
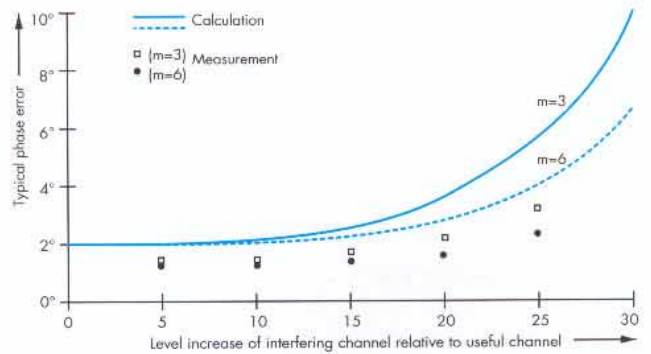

Phase and level error as a function of adjacent-channel power and adjacent-channel frequency offset

Rear panel of CMD

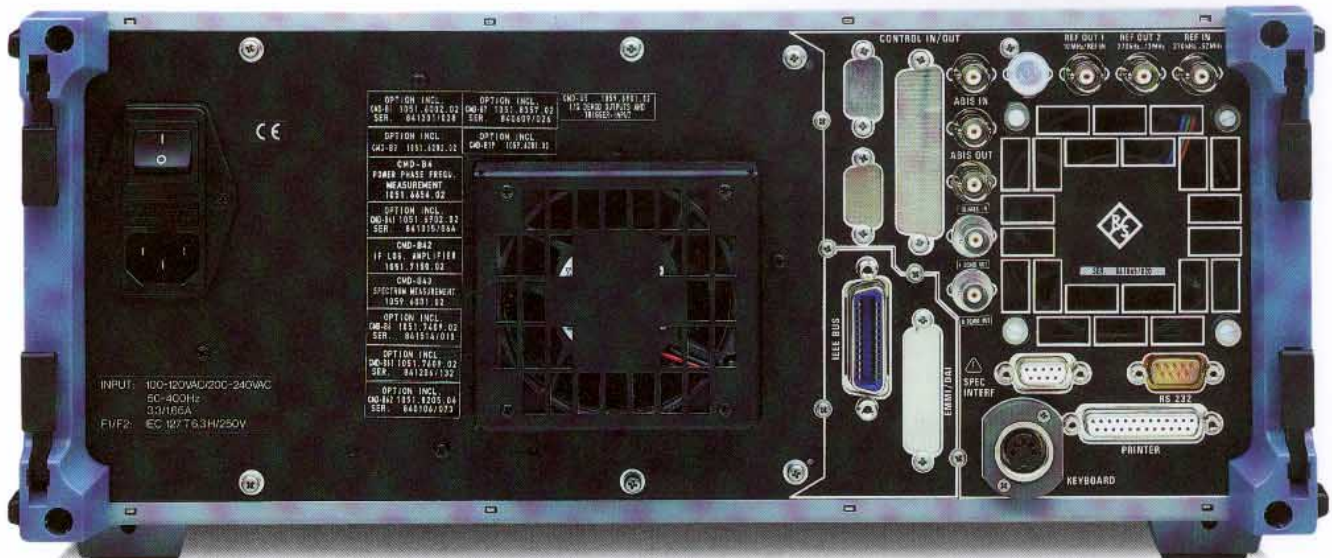



The CMD can easily be carried in the bag available as an option. For on-site measurements the CMD can be used inside the carrying bag.

Certified Quality System
ISO 9001
DQS REG. NO 1954-02



Ordering information

Designation	Type	Order No.
Digital Radiocommunication Tester* for GSM	CMD 54	1050.9008.54
Digital Radiocommunication Tester* for GSM/DCS 1800	CMD 57	1050.9008.57
Accessories supplied Power cord, operating manual, spare fuses		
Options (for both models, unless stated otherwise)		
OcXO Reference Oscillator	CMD-B1	1051.6002.02
OcXO Reference Oscillator	CMD-B2	1059.8604.02
Multi-Reference Frequency Inputs/Outputs	CMD-B3	1051.6202.02
AF Measurement Unit with Frequency Counter	CMD-B41	1051.6902.02
Realtime Speech Coder/Decoder	CMD-B5	1051.8657.02
Adapter for CMD-B6x Options	CMD-B6	1051.7409.02
IEC/IEEE Bus Interface *)	CMD-B61	1051.7609.02
Memory Card Interface *)	CMD-B62	1051.8205.02
A _{bis} Interface	CMD-B7	1051.8357.02
Test Mobile Functionality	CMD-B8	1059.8204.02
DCS 1900 Base Station Test	CMD-B19	1059.6201.02
Certified Calibration	CMD-CAL	1032.4043.07
A _{bis} Control Software	CMD-K10, -K11, etc	On request
Signalling Software	CMD-K30	1082.4530.02
UIC European Train Radiotelephony	CMD-K80	1082.4930.02
Modification Kit High-Level 2nd RF Output (13 dBm); for CMD54 only	CMD-U2	1059.6301.02
Modification Kit High-Level 2nd RF Output (11 dBm); for CMD57 only	CMD-U3	1059.6501.02
I/Q Demodulator Outputs and Trigger Input (BNC connectors on rear panel, factory installation only)	CMD-U5	1059.6901.02
Formatted Memory Cards**	CMD-Z1	1059.4809.02
Carrying Bag	CMD-Z40	1059.7808.02

* The original colours of the LCD display can be seen on the large photo on page 2/3.

** CMD-B6 also required.



ROHDE & SCHWARZ

ROHDE & SCHWARZ GmbH & Co. KG · Mühlendorfstraße 15 · D-81671 München
P.O.B. 801469 · D-81614 München · Telephone +49 89 4129-0 · Fax +49 89 4129-3567